

Smart Series

DSS15G

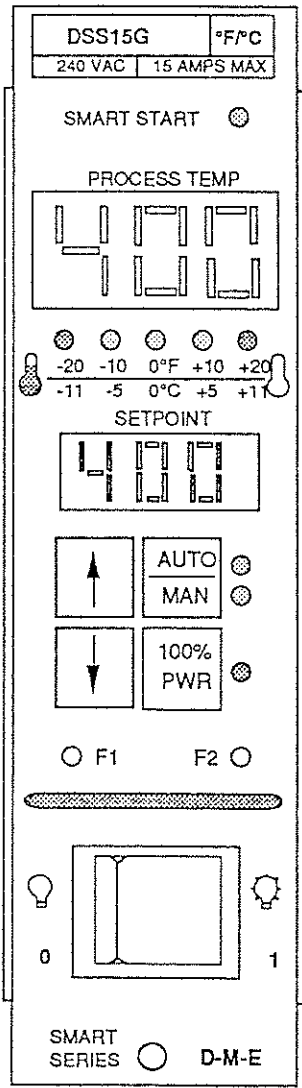

Microprocessor-Based, Dual Indicating
Temperature Control Module

User's Manual

D-M-E Company

D-M-E Standard Smart Series Microprocessor-Based Temperature Control with Dual Digital Display

General Description

The DSS is a D-M-E Smart Series, dual indicating temperature control module. This microprocessor-based control module is designed to maintain the desired set point temperature even under the most adverse processing variables. The unit incorporates features common to both the SSM and the CSS controls, such as heater bake out, input failure alarms, auto or manual operation, and solid state outputs. Other features include 100% power switch, bumpless transfer, and enhanced noise immunity.

The DSS module is designed to survive the elements that degrade control performance. Specialized circuitry is used to guard against electrical noise and static discharge.

Feature

- Dual display
- Smart Start®
- 100% power option
- EMI resistant
- Auto/Manual
- Input fault indication
- Bumpless transfer

Function

- Upper display shows process temperature while lower display shows desired set point temperature
- Safely bakes out damaging internal heater moisture.
- Break through cavity gate freeze off
- Stable/reliable operation
- Flexibility in control modes
- Alerts operator to a problem and takes corrective action
- Minimizes set point adjustment when switching to manual mode

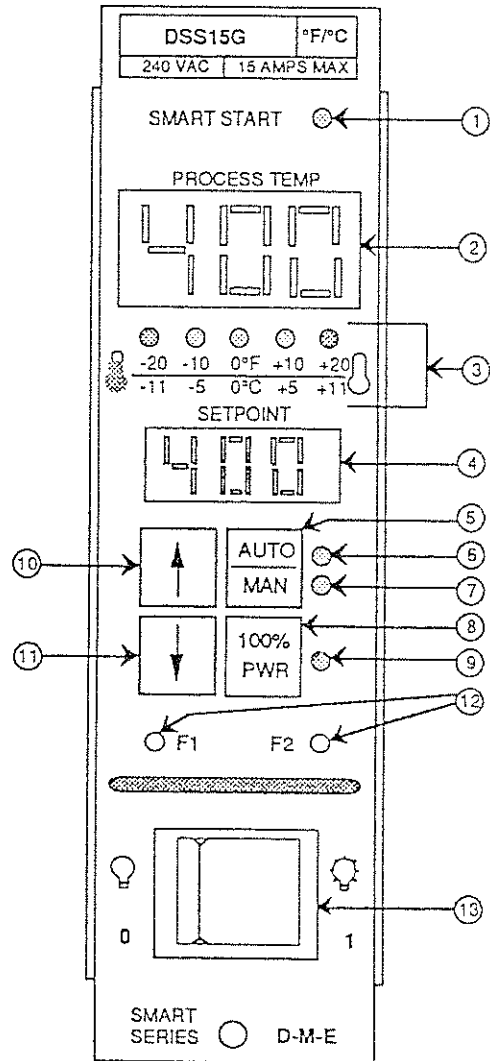

Figure 1 - DSS Keys and Displays

Keys & Displays

1. **Smart Start Light:** Indicates Smart Start is on.
2. **Process Temperature Display:** Shows process temperature and error codes.
3. **Temperature Deviation Indicators:** Displays the magnitude of process temperature deviation from set point.
4. **Set Point Display:** The auto and manual set points are displayed here.
5. **Auto/Manual Switch:** Selects automatic closed loop (temperature set point) or manual (% power) open loop control modes.
6. **Auto Light:** Auto mode is selected.
7. **Manual Light:** Manual mode is selected.
8. **100% power switch:** Initiates 100% power output. Time out is jumper selectable. See Page 5.
9. **100% Power Light:** Indicates control is in 100% power mode.
10. **Up Arrow:** Increases desired set point value.
11. **Down Arrow:** Decreases desired set point value.
12. **F1/F2 Lights:** Illuminated when fuse has blown.
13. **Power On/Off switch.**

Specifications

Performance

- **Auto and Manual Control Modes:** Time proportioning Selective Cycle[®].
- **Temperature Range:** Ambient to 999°F/537°C.
- **Control Accuracy:** $\pm 1^\circ\text{F}/0.5^\circ\text{C}$ dependent on the total thermal system.
- **Temperature Stability:** $\pm 0.5\%$ of full scale over the ambient range of 32 to 120°F/0 to 50°C.
- **Calibration Accuracy:** Better than 0.2% of full scale.
- **Power response time:** 0.538 seconds.
- **Manual Control:** Adjustable from 0 - 100%, maintains output power within 1% of set point.
- **Smart Start[®]:** Linear voltage ramping.
- **Maximum Smart Start[®] Duration:** 5 minutes.
- **Smart Start[®] Override Temperature:** 256°F/124°C
- **100% Power:** Applies 100% power to the output. Jumper selectable inhibit or S = 15, M = 30, or L = 45 seconds.
- **Operational Priority -**
 - Smart Start[®] precedes auto mode.
 - Thermocouple (T/C) break, reversed or shorted T/C overrides Smart Start[®] and auto modes.
 - Manual control overrides the auto mode, T/C breaks, reversed or shorted thermocouples.
 - Output is inhibited during all fault conditions.

Input Specifications

- **Thermocouple Sensor:** Type J, grounded or un-grounded.
- **External T/C Resistance:** Less than $0.1^\circ\text{F}/\Omega$.
- **T/C Isolation:** Isolated by control circuit power supply.
- **Cold Junction Compensation:** Automatic, better than $0.03^\circ\text{F}/^\circ\text{F}$ ($0.015^\circ\text{C}/^\circ\text{C}$).
- **T/C Break, Reversed & Shorted Protection:** Automatically inhibits power to heater.
- **Input Impedance:** 5.6 Megohms
- **Input Amplifier Stability:** Greater than $0.02^\circ\text{F}/^\circ\text{F}$ ($0.01^\circ\text{C}/^\circ\text{C}$).
- **Common Mode Rejection Ratio:** Greater than 120 dB.
- **Power Supply Rejection Ratio:** Greater than 110 dB.

Output Specifications

- **Voltage Power Capability:** 240VAC nominal, single phase, (120VAC available). 15 amperes, 3600 watts @ 240VAC (1800 watts @ 120VAC).
- **Output Drive:** Internal solid state triac, triggered by zero AC crossing pulses.
- **Overload Protection:** Fuses are provided on both sides of AC line.
- **Transient Protection:** dv/dt and transient pulse suppression included.
- **Power Line Protection:** Optically and transformer isolated from AC lines. Isolation voltage is greater than 2500 volts.

Controls and Indicators

- **Auto/Manual Selection:** Push-button switch with LED indicators adjacent to switch.
- **Set Point Adjustment:** Push-button up & down arrow keys.

- **100% Power Selection:** Push-button switch with LED indicator adjacent. Note: See J1 jumper settings on Page 5.
- **Power On/Off:** 16 Amp rocker switch.
- **Set Point Display:** Three 0.4", seven segment digit display.
- **Process Display:** Three 0.56", seven segment digit display. Also displays alarm codes and flashing "100" for 100% power operation.
- **100% Power Indication:** Red LED adjacent to 100% power key flashes. Process display flashes "100."
- **Auto Indication:** Illuminates green LED adjacent to Auto/Man key.
- **Manual Indication:** Illuminates yellow LED adjacent to Auto/Man key.
- **Smart Start[®] Indication:** Illuminates green LED above the process display.
- **Shorted T/C Indication:** Flashes "Shi" in process display.
- **Open T/C Indication:** Flashes "oPi" in process display.
- **Reversed T/C Indication:** Flashes "bcI" in process display.
- **Temperature Deviation Indicators:**
Five separate LEDs -
 $\pm 20^\circ\text{F}/11^\circ\text{C}$ = Red,
 $\pm 10^\circ\text{F}/5^\circ\text{C}$ = Yellow,
0° = Green.
- **Blown Fuse Indicators:** Two orange indicators for Fuse 1 (F1) and Fuse 2 (F2).

Electrical Power Specifications

- **Input Voltage:** 240/120 +10%/-15%.
- **Frequency:** 50/60 Hz.
- **DC Power Supplies:** Internally generated, regulated, and compensated.
- **Module Power Usage:** Less than 6 watts, excluding load.
- **Dimensions:**

Width	2.0"	5.08 cm
Height	7.0"	17.78 cm
Depth	7.5"	19.05 cm

Ordering Information

U.S.A.

PHONE ORDERS

TOLL FREE (USA)

1-800-626-6653

MAIL ORDERS

D-M-E COMPANY
29111 STEPHENSON HWY.
MADISON HEIGHTS, MI 48071
ATTN: ORDER DEPT.

SERVICE CENTERS U.S.A.

WORLD HEADQUARTERS
29111 STEPHENSON HIGHWAY
MADISON HEIGHTS (DETROIT)
MICHIGAN 48071
TELEFAX: (313) 398-6174

Displays & Indicators

Upper Display

The upper display is a three digit, seven segment display showing process temperature and error codes.

With a thermocouple in manual mode, the display reads process temperature. While in the manual mode, without a thermocouple, the display reads oPI (open input). The display range is from ambient to 999°F/537°C. See Page 6 for diagnostic information displayed when an input fault is present.

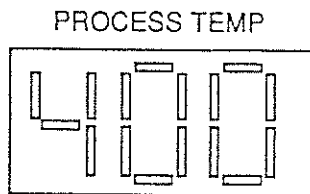

Figure 2 - DSS Upper Display

Lower Display

The lower display is a three digit, seven segment display used to show set point. The manual, auto, and 100% power modes are shown here. The **AUTO/MAN** key selects between automatic and manual operation, while the **100% PWR** key selects 100% power mode.

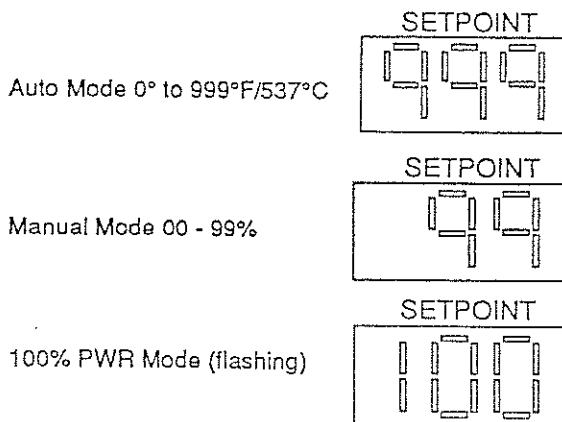

Figure 3 - DSS Lower Display

LED Indicators

SMART START -

During Smart Start the green LED is on.



Deviation LEDs -

Green indicates $< \pm 10^\circ\text{F}/5^\circ\text{C}$ temperature deviation.
 Yellow indicates $> \pm 10^\circ\text{F}/5^\circ\text{C}$ temperature deviation.
 Red indicates $> \pm 20^\circ\text{F}/11^\circ\text{C}$ temperature deviation.
 Flashing red indicates $> \pm 40^\circ\text{F}/^\circ\text{C}$ temperature deviation.

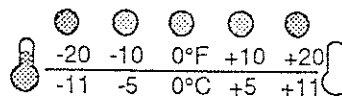

AUTO -

The green LED adjacent to the Auto key is on while in the automatic mode.

MAN -

The yellow LED adjacent to the Man key is on while in the manual mode.

100% PWR -

The red LED next to the 100% PWR key flashes while in 100% power mode. All other LEDs are off in this mode.

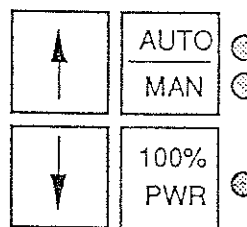

Figure 4 - DSS Keys and Displays

F1 and F2 -

The orange neon light is on when its corresponding fuse blows.

Keys

AUTO/MAN

The Auto/Man key provides either automatic or manual percent power control. Adjust the temperature set point while in the Auto mode. The Auto mode is indicated by the green LED. Adjust the percent power while in the manual mode. Manual is indicated by the yellow LED.

Operation

Automatic Mode

The microprocessor maintains temperature using a closed loop PID control method. Closed loop means the unit continuously looks at the process temperature to determine whether or not to adjust the power delivered to the heater. With PID control, it anticipates the system characteristics to make accurate adjustments and correct for errors.

Auto-tuning

Auto-tuning PID parameters are automatically initiated after power up, or when the set point is changed by greater than 100°F. Auto-tuning begins when the process temperature is at 80% of set point. During auto-tuning the heat proportional band is set to 0, and the control goes into the ON/Off mode at 90% of the established set point. Once the control finishes "learning" the system, it returns to a standard PID control with the heat PID values automatically set as a result of auto-tuning.

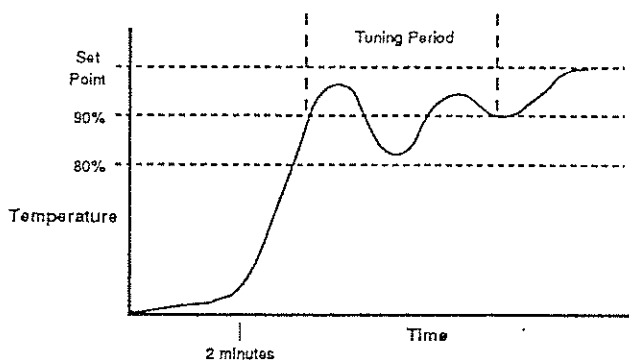

Bumpless Transfer

While in the auto mode and within 5°F of set point, the control periodically calculates and records the average percent power required to keep the process temperature at set point. When the control is switched to manual mode, the last stored percent power becomes manual set point if 5°F was met. Percent power is stored if an input failure occurs.

UP/DOWN Arrows

Adjust the auto or manual set point via the up/down arrow keys. The new set point is automatically entered 1 second after the last key is pressed.

100% PWR

When the 100% PWR key is pressed, 100% power is applied to the load for a time period determined by the J1 jumper. See below. Press any key to disable, and the control returns to auto mode. When in 100% power, it is indicated by the red LED flashing next to the 100% PWR key, and "100" flashing in the lower display.

Power-Up

Upon power up, the unit retains the same set point and operation mode as when the unit was turned off. If the unit is turned off while at 100% power, upon power up it returns to the mode and set point retained before switching to 100% power.

Input Fault

Thermocouple break protection, and shorted or reversed thermocouple all override Smart Start® and normal modes. Output is inhibited, although bumpless transfer may be used to override.

Manual Mode

For open thermocouple or thermocouple failure, open loop-percent power is used. In manual mode, the microprocessor maintains a power level using an open loop power control method. Open loop means the process temperature is not used to determine whether or not adjustments should be made. This enables the user to continue production and override thermocouple wire breaks, short circuits, or lead reversal until the problem has been resolved. Manual mode overrides thermocouple break protection, reversed thermocouple, and any normal modes.

Smart Start®

Smart Start is automatic on start-up in the auto mode, and provides a linear ramp to set point for heater bake out. Smart Start is complete when five minutes expire or when set point is reached.

100% Power

When 100% PWR is pressed, the output is full on until the timeout period is complete. Maximum time duration for 100% power is determined by the J1 jumper, see Figure 5 on Page 7. Located on the printed circuit board, S = 15 seconds, M = 30 seconds, L = 45 seconds, & INH = inhibit 100% power. See Page 7 for location. Pressing any key during timeout returns the unit to its previous mode and set point.

Diagnostics

The DSS diagnostics automatically alert the user to a fault condition.

1. Shorted thermocouple

Displays flashing **ShI** in the auto mode (output inhibited), or is on steady in the manual mode.

Troubleshooting -

Check for damage to the thermocouple lead wire. Also, check for bare, twisted or pinched leads.

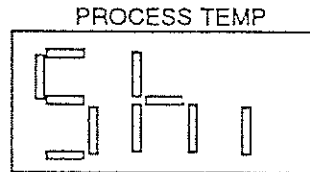

2. Open thermocouple

Indicated by **oPI** flashing while in the auto mode (output inhibited), or on steady in the manual mode.

Trouble shooting -

Check the thermocouple connections and wires for broken leads or check for damage to the sensor.

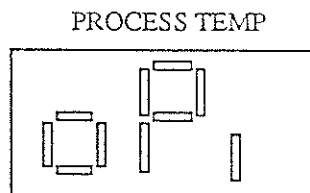

3. Reversed thermocouple

Displays flashing **bci** while in the auto mode (output inhibited), or on steady in the manual mode.

Troubleshooting -

Check thermocouple wiring for reversed leads.

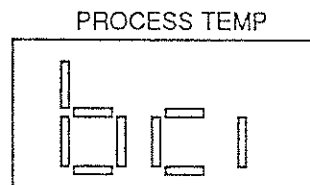

4. Over/Undertemperature

The red deviation LED on the left, flashes when the process temperature is below set point by 40°F or more. The red deviation LED on the right flashes when the process is above set point by 40°F or more.

Troubleshooting -

Check for:

- undertemperature
- heater failure
- overtemperature
- output failure

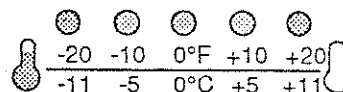

Return Policy

The D-M-E DSS modules are warranted for 90 days parts and labor, excluding fuses.

Contact D-M-E Customer Service for return authorization for repairs or warranties. Replacement parts are also available through the Customer Service Department.

D-M-E Customer Service

In U.S., West Coast: 1-213-263-9261

Elsewhere in U.S.: 1-800-626-6653

In Canada: 1-416-677-6370

Replacement Parts List

To meet warranty requirements, use only DME parts.

Designation	Description	Supplier Part #	DME Part #
• F1	Fuse, 15A, 250V	ABC 15 Bussman only	ABC 15
• F2	Fuse, 15A, 250V	ABC 15 Bussman only	ABC 15
• T1	Transformer, 240/120, Split Bobbin 12V @ 500mA, 24V @ 1A		RPM 0020
• U6	Microprocessor (contains DME proprietary software)		RPM 0021
• Q1	Triac Driver		RPM 0022
• Not Shown (mounted to heatsink)	Triac - (Note: must apply a thin coat of heatsink compound.)	Q6040P	RPM 0023
• SW1 - Not Shown (mounted on faceplate)	Power Switch, 16A, 250V		RPM 0024

*** To Convert from 240VAC to 120VAC**





- B10 - Jumper installed
- B9 - Jumper not installed
- B8 - Jumper installed

To convert from 120VAC to 240VAC

- B10 - Jumper not installed
- B9 - Jumper installed
- B8 - Jumper not installed

100% PWR Timer Settings

Install the jumper as shown. The module is shipped with a jumper in the "S" position.

- S = 15 seconds 
- M = 30 seconds 
- L = 45 seconds 
- INH = Inhibit 

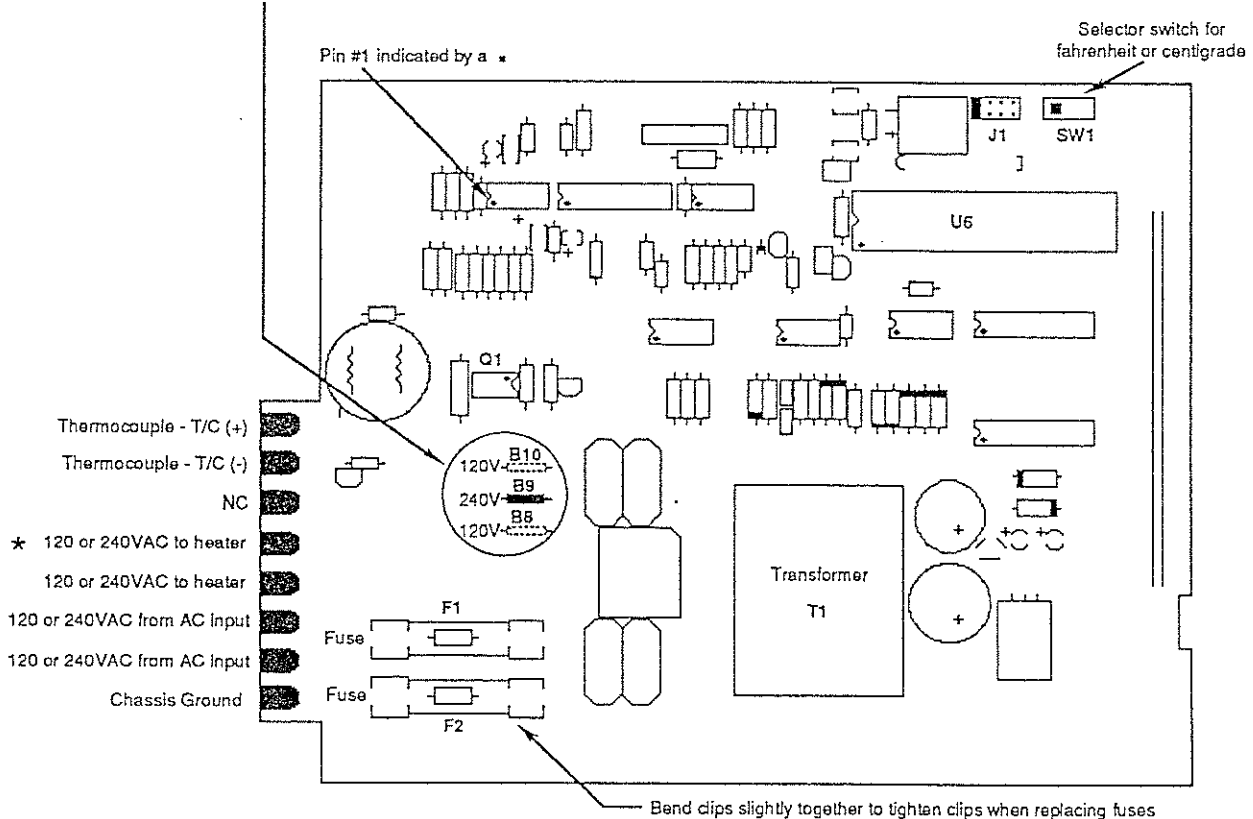

Figure 5 - DSS Board Layout

D-M-E DSS User's Manual

D-M-E, 29111 Stephenson Highway, Madison Heights, MI 48071, Phone: 800-626-6653, Fax: 313-398-6174

Calibration Instruction for the DSS15G Controller

Equipment needed:





1. Type J thermocouple simulator

Test Procedure:

1. Connect the thermocouple simulator to the thermocouple input on the DSS15G.
2. Record position of S & M & L jumpers. Now Insert jumpers in positions S & M & L on jumper J1. The inhibit position does not require a jumper.
3. Power the unit on and wait 5 minutes for warm up. The displays will indicate "CAL 0".
4. Set the thermocouple simulator to 32°F and wait five seconds.
5. Press the down arrow key one time. After approximately 10 seconds the displays will indicate "CAL 999".
6. Set the thermocouple simulator to 1000°F and wait five seconds.
7. Press the "AUTO/MAN" key one time. After approximately 10 seconds the displays will indicate "CAL End".
8. Press the 100% Power key one time. The upper display will indicate "999" and the lower display will indicate "75".
9. Turn power off. Return the appropriate jumper that was recorded in step 2 - S or M or L. The unit is now calibrated.

100% PWR Timer Settings

Install the jumper as shown. The module is shipped with a jumper in the "S" position.

S	= 15 seconds	
M	= 30 seconds	
L	= 45 seconds	
INH	= Inhibit	

Calibration Mode = 
S & M & L jumpers installed

